

Store SunBox

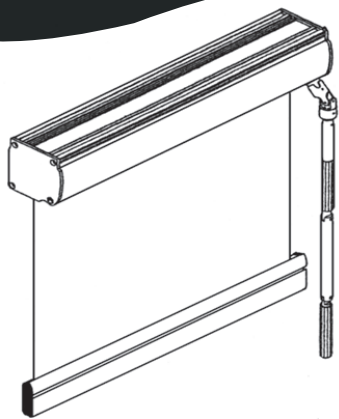

Descriptif général

- Caisson de 63 ou 83 mm en aluminium extrudé avec sous face arrondie démontable donnant accès au mécanisme disponible en Alu naturel ou laqué blanc 9016 (autres RAL en option).
- Tube d'enroulement Ø 35 mm ou 45 mm en aluminium.
- Tablier en toile pare-soleil ou opaque coloris au choix.
- lame finale ronde Ø 18 mm ou plate de 42 x 12 mm en alu.
- Manœuvre par treuil et manivelle fixe de série.
- Motorisation en option.
- Fixation face / plafond par supports clips en aluminium.

Accessoires de pose

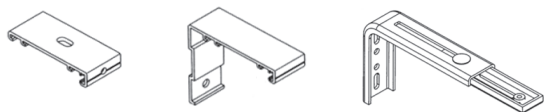

Clip-étrier plafond de série

Clip-étrier de face en option

Equerre de face en option

Choix de manœuvres

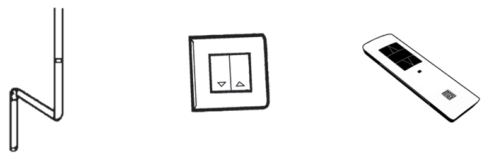

Manivelle Treuil

Motorisation filaire

Motorisation radio

Option guidage câbles acier



Equerre de face

Pontet au sol

Equerre fenêtre PVC

Option guidage coulisses alu



Coulisse Solaire SO

Coulisse Occultante OC

RO XL
SB63 & SB83

SOLTIS 92 :

Screen pare-soleil, 43% polyester, 57% PVC, classement au feu M1

- Grammage : 420 g/m² • Epaisseur : 0,45 mm • Solidité coloris : 7

TOILE PARE-SOLEIL M1



92.2044* SB63/83

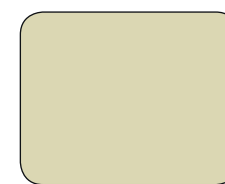

92.2175 SB63/83

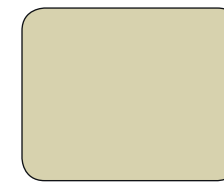

92.50265 SB63/83

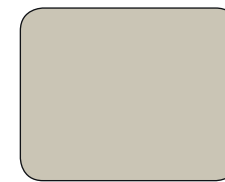

92.2135* SB63/83

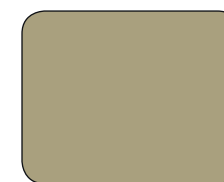

92.2012 SB63/83



92.50266 SB63/83

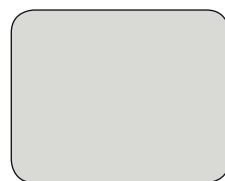

92.50272* SB63/83



92.2171* SB63/83



92.2167 SB63/83



92.2047 SB63/83



92.2161 SB63/83



92.50270 SB63/83



92.50264 SB63/83



92.50336 SB63/83



92.2013 SB63/83

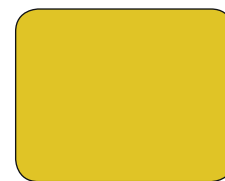

92.2166 SB63/83

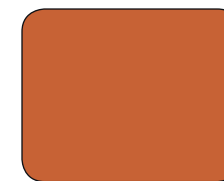

92.2172 SB63/83



92.8255 SB63/83

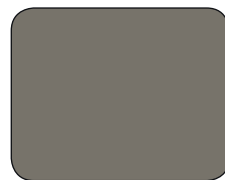

92.50266 SB63/83

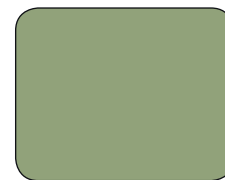

92.2158 SB63/83

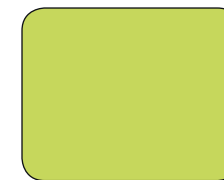

92.50333 SB63/83

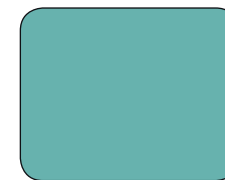

92.50269 SB63/83



92.2045* SB63/83



92.2149 SB63/83



92.2043* SB63/83

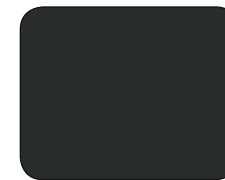

92.2053 SB63/83

SUNBOX

* : Les tissus signalés par des astérisques se font aussi en finition opaque avec une enduction PVC, classement au feu M2